

# SHARP



Refrigerant; HFC-134a

Insulation blowing gas; Cyclopentane

冷媒種類； HFC-134a

絕緣發泡材主要成份； 環戊烷

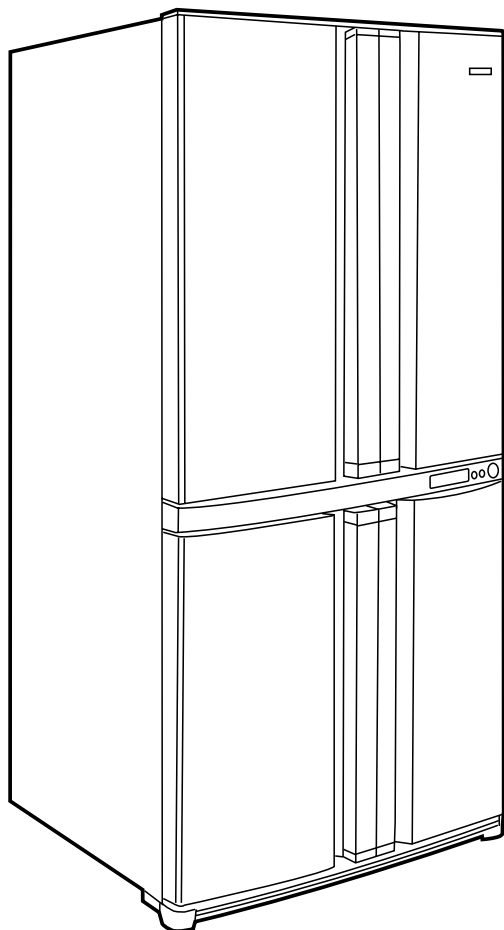

Thank you very much for buying this SHARP product. Before using your SHARP refrigerator, please read this operation manual to ensure that you gain the maximum benefit from it.

感謝您購買 SHARP 產品。在使用 SHARP 電冰箱之前，為使您能夠充份使用您所購買的冰箱，請仔細閱讀本使用說明書。

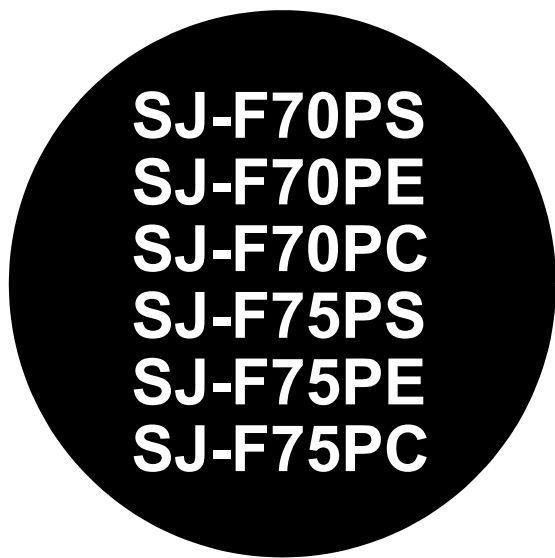

Model name 型名

SJ-F70PS-SL, SJ-F70PE-BE, SJ-F70PE-SL  
SJ-F70PE-WH, SJ-F70PC-BE, SJ-F70PC-SL  
SJ-F70PC-WH, SJ-F75PS-SL, SJ-F75PE-BE  
SJ-F75PE-SL, SJ-F75PE-WH, SJ-F75PC-BE  
SJ-F75PC-SL, SJ-F75PC-WH

## REFRIGERATOR - FREEZER OPERATION MANUAL

原裝進口電冰箱  
使用說明書

### CONTENTS

• WARNING .....	3
• CAUTION .....	3
• INSTALLATION .....	4
• DESCRIPTION .....	5
• OPERATION (USING THE CONTROL PANEL) .....	7
• STORING FOOD .....	10
• CARE AND CLEANING .....	10
• WHAT TO DO BEFORE YOU CALL FOR SERVICE .....	10

### 目錄

• 警告 .....	11
• 安全注意事項 .....	11
• 安裝 .....	12
• 各部位名稱 .....	13
• 使用方法（使用控制面板） .....	15
• 食品的儲存 .....	18
• 保養 .....	18
• 送修之前的初步檢查 .....	18



1. This refrigerator is airtight. TO PREVENT FATAL ACCIDENTS TO CHILDREN, please completely remove the door prior to discarding the refrigerator.
2. Highly volatile and inflammable materials such as ether, petrol, propane gas, adhesive agents and pure alcohol etc. are liable to explode. Do not store these materials in the refrigerator.
3. To prevent damage to the outer cabinet, avoid contact with lacquer, and paint, etc.
4. When cleaning your refrigerator, do not splash water directly on the outer cabinet or the interior. This may lead to rusting and deterioration of the electrical insulation.
5. When cleaning any areas adjacent to electrical components, unplug the refrigerator first to prevent electric shock.
6. Should electrical components be accidentally immersed in water, unplug the refrigerator, dry the parts and contact your nearest service agent approved by SHARP.
7. When disconnecting the power plug, do not touch the pin of plug. This may cause electric shock.
8. This refrigerator is designed solely for the purpose of storing foodstuff for domestic use in accordance with the instructions given in this manual. Using the refrigerator for other purposes might be harmful to persons or property.
9. This refrigerator is not suitable for the storage of materials requiring precise temperatures. Deterioration of these materials will be dangerous.
10. Dust deposited on the power plug may cause fire. Wipe it off carefully.
11. Do not attempt to change or modify this refrigerator. This may result in fire, electric shock or injury.
12. **Information regarding disposal of the appliance**  
Flammable insulation blowing gases should be disposed appropriately. Take the cabinet and doors to a recycling plant for flammable insulation blowing gases.

## CAUTION

1. If the power supply is accidentally disconnected, please wait for at least 5 minutes before re-connecting the power, as back pressure in the compressor may trip the overload relay.
2. Do not touch foods or metal containers in the freezer compartment with your wet hands. This may cause frostbite.
3. To prevent accidental power disconnection, plug the refrigerator directly to the source. Do not use a double adaptor as loss of power could lead to the spoiling of the stored food.
4. Do not place bottles in the freezer as they may crack when frozen.
5. Keep the door securely closed. If the door is left ajar, the controlled inner temperature will rise, resulting in food spoilage and increase in electricity costs.
6. Do not install the refrigerator in a damp or wet location as this may cause damage to the insulation and a leak. Condensation may also build on the outer cabinet and cause rust.
7. When installing or moving the refrigerator, make sure that you do not nip or kink the power cord. Damage of the power cord may cause electric shock or fire.
8. Do not use this refrigerator when the power cord or plug is damaged, or the outlet attachment is loose, as they may cause electric shock or fire.
9. Disconnect from the mains electricity supply by removing the mains plug from the electricity supply socket. Do not remove by pulling the mains lead. This may cause electric shock or fire.
10. Make sure that you leave adequate ventilation space around the refrigerator to prevent the compressor from overheating and stopping. Please follow the instructions given for installation.
11. The refrigeration system behind and inside the refrigerator contains refrigerant. If this system is punctured it could result in serious damage to your refrigerator, therefore do not allow any sharp objects to come into contact with the refrigeration system.
12. Should the flexible supply cord be damaged, it must be replaced by service agent approved by SHARP as a special cord is required.
13. In case of gas leak, ventilate the area by opening a window, etc. Do not touch the refrigerator or the power outlet.
14. Do not place heavy or easily broken objects on top of the refrigerator. Objects may fall when opening or closing the refrigerator, causing injury.
15. Do not place objects containing liquid on top of the refrigerator. Spillage may cause electric shock or fire.
16. Do not drop objects inside the refrigerator or strike the inner wall. This may cause the inner surface to crack.
17. This refrigerator is not intended for use by young children or infirm persons without supervision. Young children should be supervised to ensure that they do not play with the refrigerator.

# INSTALLATION

1. To ensure adequate ventilation for your refrigerator, it is recommended to provide space of 6cm on both sides and at the back, and space of 9cm above the refrigerator. Insufficient spacing will decrease the cooling efficiency, resulting in unnecessary consumption of electricity.

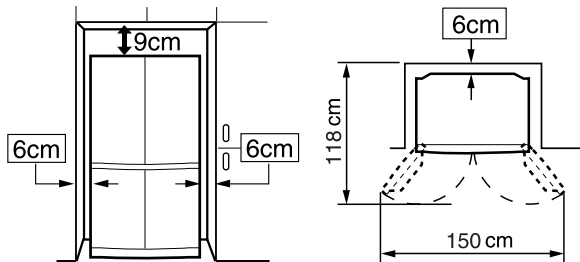

2. Using the two front Adjustable feet, ensure that the refrigerator is positioned firmly and level on the floor.

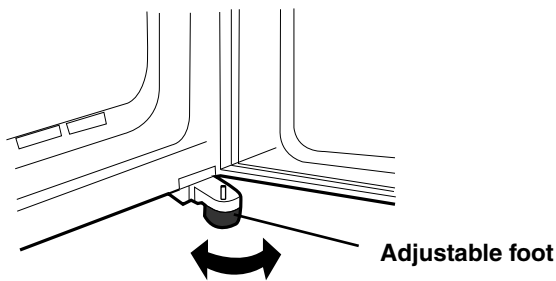

3. When right and left doors are not properly aligned, adjust using the adjustable feet.

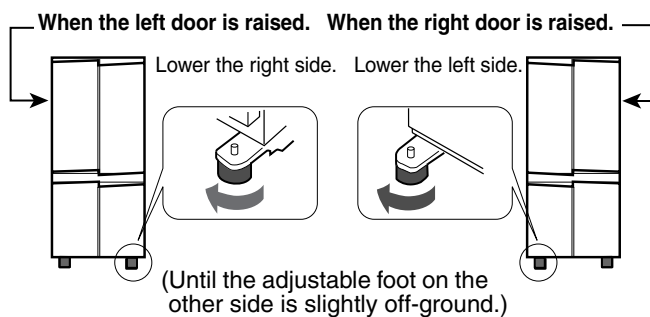

4. Remove the 4 screws of the cabinet lower part, and then set the foot cover (supplied inside the refrigerator compartment) with removed 4 screws.

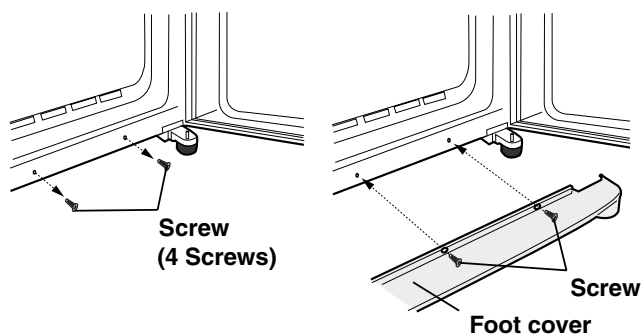

5. In order to prevent possible electric shock, install the grounding wire to the earth wire connecting screw at the rear of the refrigerator. (2 pin plug region)

## NOTE:

- Position your refrigerator so that the plug is accessible.
- Keep your refrigerator out of direct sunlight.
- Do not place next to heat generating appliance.
- Do not place directly on the ground. Provide suitable stand.
- To insert the power plug when the door is opened, door alarm sounds but it is not abnormal. This sound stops when closing the door.

## When transporting

- Using the casters, it is possible to move back and forth.



- Carry the refrigerator by holding the handles located on the rear and bottom.

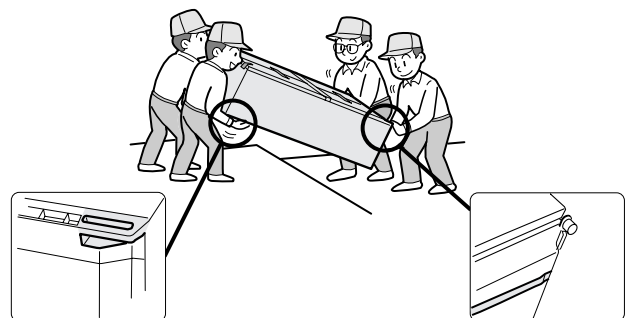

## Before using your refrigerator

- Clean the inside parts with a cloth soaked in warm water. If soapy water is used, wipe it off thoroughly.

# DESCRIPTION

SJ-F75PS, SJ-F75PE, SJ-F75PC

SJ-F70PS  
SJ-F70PE  
SJ-F70PC

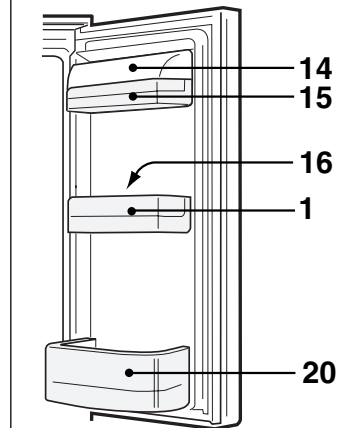
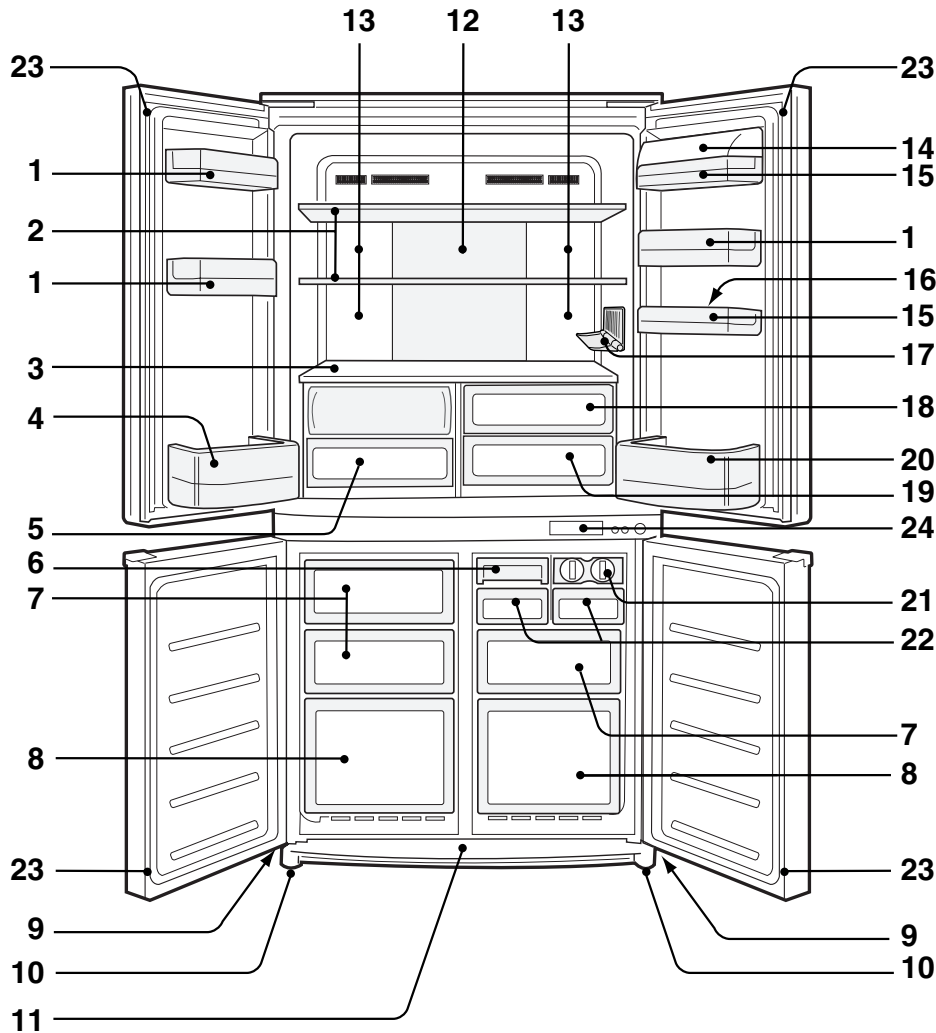

- 1. Door pocket
- 2. Refrigerator shelf
- 3. Shelf
- 4. Bottle pocket (left)
- 5. Vegetable crisper

The cover of the Vegetable crisper opens as the case is pulled.

- 6. Quick ice maker (\*)

The bottom of the tray contains refrigerant material used in ice packs to speed up the ice making process. The tray can also be used to freeze small food items such as meat and fruits by removing the ice making partition.

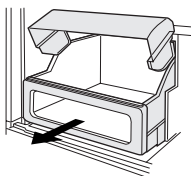

- 7. Freezer case (small)
- 8. Freezer case (large)
- 9. Casters

- 10. Adjustable feet
- 11. Foot cover

- 12. Aluminum panel

The panel is cooled from the rear, thus indirectly cooling the refrigerator compartment. In this way, food is refrigerated gently, without exposing it to cold air flow.

- 13. Light
- 14. Utility pocket cover
- 15. Utility pocket (\*)
- 16. Egg holder

- 17. Bottle rack (\*)



- 18. Fruit case

- 19. Fresh case

- 20. Bottle pocket (right)

To store large-size bottles, move the partition all the way back.

Partition

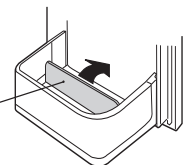

- 21. Ice cube maker (\*)

- Do not over fill the tray; otherwise the ice cubes will be joined together when frozen.
- When the ice cubes are made, turn the lever clockwise to empty the ice into the Ice cube box.

Lever

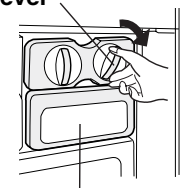

Ice cube box

- 22. Ice cube box

To prevent damage to the Ice cube box, do not make ice in the Ice cube box or pour oil into it.

- 23. Magnetic door seal

- 24. Control panel

*	SJ-F70PS	SJ-F70PE	SJ-F70PC	SJ-F75PS	SJ-F75PE	SJ-F75PC
6. Quick ice maker	1	0	0	1	0	0
15. Utility pocket	1	1	1	2	2	2
17. Bottle rack	1	1	0	1	1	0
21. Ice cube maker	1	2	2	1	2	2

# CONTROL PANEL

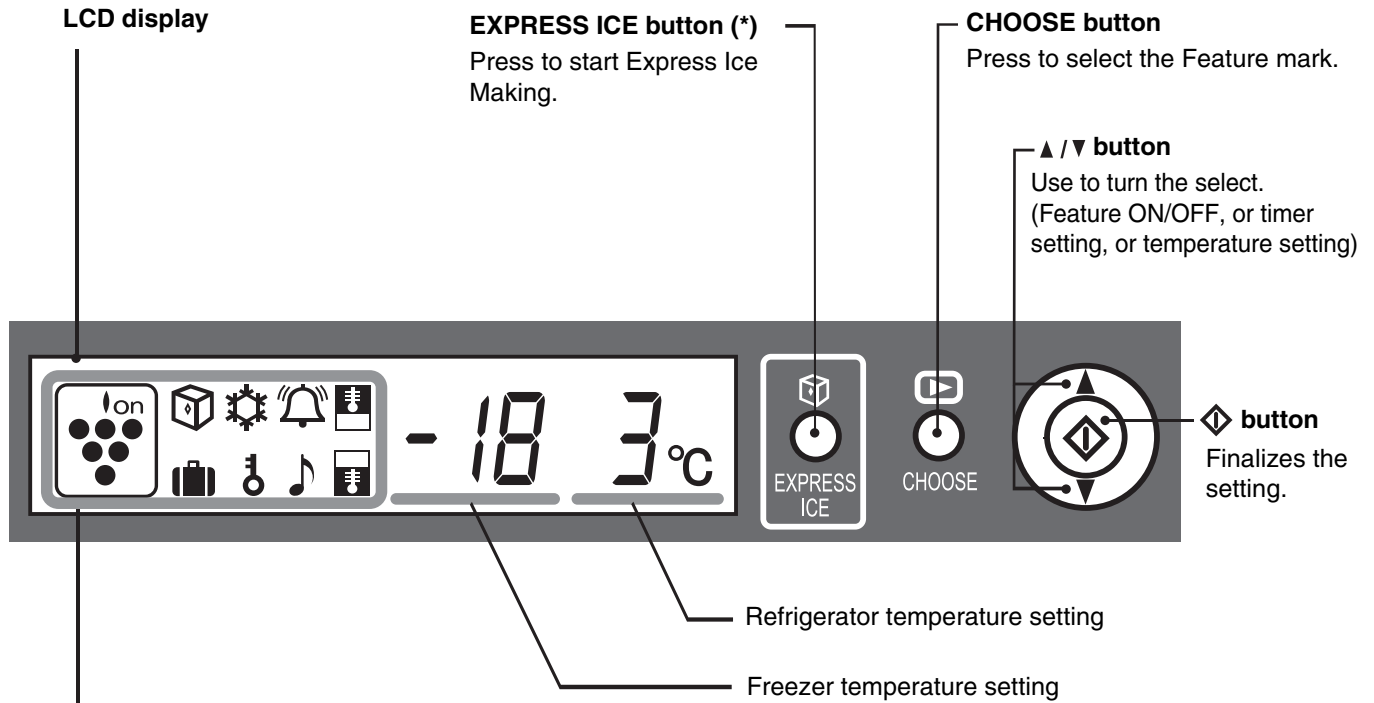

## Each feature mark

<b>Plasmacluster</b>	<b>Refrigerator temp. control</b>
<b>Express Ice Making (*)</b>	<b>Freezer temp. control</b>
<b>Express Freezing (*)</b>	<b>Door alarm</b>
<b>Timer</b>	<b>Child lock</b>
	<b>Vacation mode (*)</b>

• Marks of features in operation are displayed.

• Features that start automatically when inserting the power plug.

• When the refrigerator stops with power failure and the like, display at the time of re-power distribution shows similarly as before having a power failure. However, when it has a power failure during operation of Express Ice Making, Express Freezing, and Timer, operation is stopped at the time of re-power distribution.

\* : Only for SJ-F70PS, SJ-F70PE, SJ-F75PS, SJ-F75PE

## NOTE:

- When no operation is made for 30 seconds, the display will automatically return to the initial content. The backlight will become dark when there is no operation for 3 minutes. The backlight will turn off when there is no operation for 6 minutes.
- Do not hit or apply sharp object on to the LCD panel.

## DEODORIZING UNIT

A built-in unit which requires no manual operation because it automatically starts operating when the refrigerator is powered on.

## DEFROSTING

- Defrosting is fully automatic due to a unique energy saving system. Whereby the defrost cycle start time is proportional to the running time of your refrigerator compressor, i. e., the less time the refrigerator compressor operates (during the winter season or you're away on holidays), the longer the time between each defrost cycle.
- The defrost water collects in the evaporating pan, where it is evaporated by the heat of the compressor, etc.
- The evaporating pan does not require cleaning or maintenance.

# OPERATION (USING THE CONTROL PANEL)



## Controlling Temperature

The refrigerator controls its temperature automatically. However, if needed, adjust the temperature as follows.

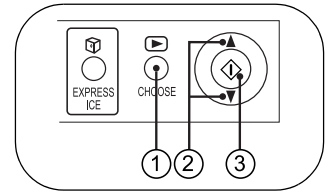

### Refrigerator compartment

- 1 Press the "CHOOSE" button and select the "Refrigerator temp." mark.

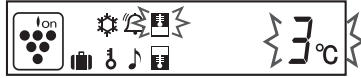

- 2 Press the ▲ / ▼ button and set the temperature. [ ▲ : increase, ▼ : decrease ]

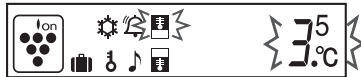

- 3 Press the "◊" button.



Adjustable between 0°C and 6°C in steps of 0.5°C.

↑ 6°C	When the refrigerator provides excessive cooling.
3°C	For normal operation.
↓ 0°C	For keeping foods fresher tasting. When the refrigerator does not provide sufficient cooling.

#### NOTE:

- If the refrigerator is operated for a long time with Refrigerator Temp. Control set at 0°C, foods stored in the refrigerator compartment may also freeze.
- Low ambient temperature may cause placed foods to freeze even if Refrigerator Temp. Control is set to 6°C.

### Freezer compartment

- 1 Press the "CHOOSE" button and select the "Freezer temp." mark.



- 2 Press the ▲ / ▼ button and set the temperature. [ ▲ : increase, ▼ : decrease ]



- 3 Press the "◊" button.

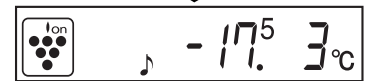
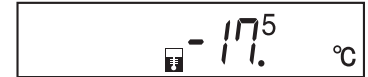

Adjustable between -13°C and -21°C in steps of 0.5°C.

↑ -13°C	When frozen food or ice cream is not stored.
-18°C	For normal freezing.
↓ -21°C	For making ice rapidly or fast freezing.

#### NOTE:

- If the refrigerator is operated for a long time with Freezer Temp. Control set at -21°C, foods stored in the refrigerator compartment may also freeze.



## Express Ice Making (Only For SJ-F70PS, SJ-F70PE, SJ-F75PS, SJ-F75PE)

Ice cubes can be made quicker than normal.

- This feature cannot be used simultaneously with Express Freezing.

- 1 Press the "EXPRESS ICE" button.



The mark appears and operation starts.

- 2 When the ice is completed, remove the ice.

### How to use the Quick ice maker

(Only for SJ-F70PS, SJ-F75PS)

- Cool the Quick ice maker beforehand in the freezer (for at least 1 day).
- When the ice cubes are made, remove the partition from the tray, after that twist the both ends of the partition and drop the ice.

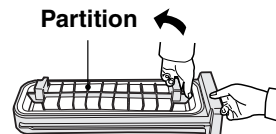

### To cancel operation

Press the "EXPRESS ICE" button again.

#### NOTE:

- Express Ice Making ends automatically in about 1 hour regardless of ice condition. (The mark disappears.)
- Express Ice Making may require more than 1 hour in the case operation overlaps with defrosting as operation is started after defrosting is completed.
- Avoid opening the door as much as possible during operation of this feature.

#### • Standard time until the ice is completed : approx.20 minutes

- When using the water stored in the refrigerator compartment, at a room temperature of 30°C and with the refrigerator set to 3°C and the freezer to -18°C.
- Ice making time may become longer than above description depending upon room temperature and water temperature and the opening and closing frequency of the door etc.
- Ice making cannot be completed in approx. 20 minutes if pouring the water exceeding the water level line. Also it becomes difficult to remove the ice.

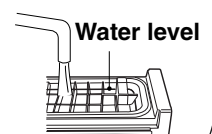

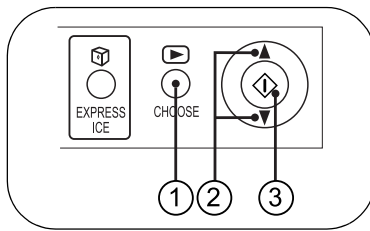

## Plasmacluster

The plasmacluster automatically starts operating when the refrigerator is powered on.

### To cancel operation

- Press the "CHOOSE" button and select the "Plasmacluster" mark.



- Press the ▲ / ▼ button and select "OFF".



- Press the "◇" button.



### To start operation

Select "ON" in step ②.

#### Notes about PLASMACLUSTER operation

The ionizer inside your refrigerator releases clusters of ions, which are collective masses of positive and negative ions, into the freezer and refrigerator compartments. These ion clusters inactivate airborne mold fungus.

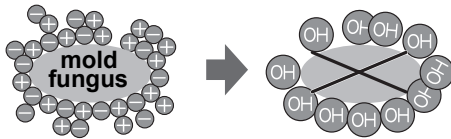

- There may be a slight odors in the refrigerator. This is the smell of ozone generated by the ionizer. The amount of ozone is minimal, and quickly decomposes in the refrigerator.



## Timer

Up to 99 minutes 30 seconds can be set in interval of 30 seconds.

- Press the "CHOOSE" button and select the "Timer" mark. Previous set time is displayed.



- Press the ▲ / ▼ button and set the time.

[ ▲ : increase, ▼ : decrease ]

Push the button continuously, the setting can be configured quickly.



- Press the "◇" button.



Timer starts. The remaining time is displayed.

When the set time is reached, the end tone will sound. (About 30 sec.)

To stop the end tone, press "◇".



### To cancel the timer

- Press "CHOOSE" to select the "Timer" mark.



- Press the "◇" button.

#### NOTE:

During Timer operating it is not possible for the second time to set Timer.



## Express Freezing (Only For SJ-F70PS, SJ-F70PE, SJ-F75PS, SJ-F75PE)

High-quality frozen foods can be made using this feature and is convenient for home-freezing.

- This feature cannot be used simultaneously with Express Ice Making.

- Press the "CHOOSE" button and select the "Express freezing" mark.



- Press the ▲ / ▼ button and select "ON".



- Press the "◇" button.

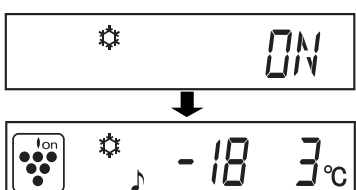

Express Freezing ends automatically in about 2 hours. (The mark disappears.)

### To cancel operation

Select "OFF" in step ②.

#### NOTE:

- Large foods cannot be frozen in a single operation.
- Express Freezing may require more than 2 hours in the case operation overlaps with defrosting as operation is started after defrosting is completed.
- Avoid opening the door as much as possible during operation of this feature.



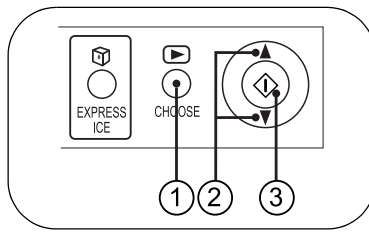

## Door Alarm

When the refrigerator or freezer door is left open, the door alarm will sound.

- The door alarm will sound 1 minute after opening the door and again after 1 minute (once in each case).
- If the door is left open for approx. 3 minutes, the alarm will sound continuously.

### To cancel operation

- 1 Press the "CHOOSE" button and select the "Door alarm" mark.



- 2 Press the ▲ / ▼ button and select "OFF".



- 3 Press the "◇" button.

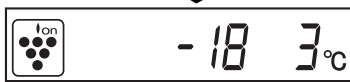

### To start operation

Select "ON" in step ②.

## Child Lock

Key operations of the control panel can be disabled. Use this feature to prevent children or someone from tampering with the panel.

- 1 Press the "CHOOSE" button and select the "Child lock" mark.

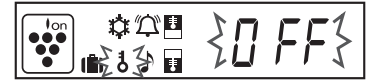

- 2 Press the ▲ / ▼ button and select "ON".



- 3 Press the "◇" button.



### To cancel operation

- 1 Press the "CHOOSE" button continuously 2 seconds or more.

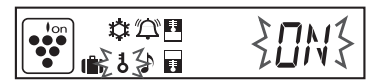

- 2 Select "OFF" with the ▲ / ▼ button and press the "◇" button.

## Vacation Mode (Only For SJ-F70PS, SJ-F70PE, SJ-F75PS, SJ-F75PE)

Use this feature when going on a trip or leaving the house for a long time.

- 1 Press the "CHOOSE" button and select the "Vacation mode" mark.



- 2 Press the ▲ / ▼ button and select "ON".

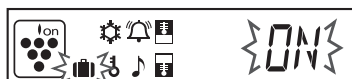

- 3 Press the "◇" button.

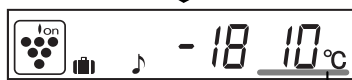

The temperature inside the refrigerator compartment will be adjusted to 10°C. This temperature cannot be modified.

### To cancel operation

Select "OFF" in step ②.

### NOTE:

Food storage period in the refrigerator compartment becomes approx. 1/2 - 1/3 of normal operation, because the temperature of the refrigerator compartment inside becomes 10°C. Please utilize only when there is no perishable food.

# STORING FOOD

Refrigeration reduces the rate of food spoilage. To maximize the shelf life of perishable food products, ensure that the food is of the freshest possible quality. The following is a general guide to help promote longer food storage.

## Fruit / Vegetables

To minimize moisture loss, fruit and vegetables should be loosely enclosed in a plastic material e.g. wrap, bags (do not seal) and place in the Vegetable crisper or the Fruit case. Those fruits and vegetables with thick skins e.g. oranges do not require wrapping.

## Dairy Products & Eggs

- Most dairy products have a use by date on the outer packaging which informs the recommended temperature and shelf life of the product.
- Eggs should be stored in the Egg holder.

## Meats / Fish / Poultry

- Place on a plate or dish and cover with paper or plastic wrap.
- For larger cuts of meat, fish, or poultry, place to the rear of the shelves.
- Ensure all cooked food is wrapped securely or placed in an airtight container.

## NOTE:

- Evenly place the food on the shelves to allow the cooling air to circulate efficiently.
- Hot foods should be cooled before storing. Storing hot foods increases the temperature in the unit and increases the risk of food spoilage.
- Do not block the outlet and inlet of the cool air circulating circuit with foods or containers; otherwise the foods will not be evenly cooled throughout the refrigerator.
- Do not place food directly in front of cold air outlet. This may lead to the food freezing.

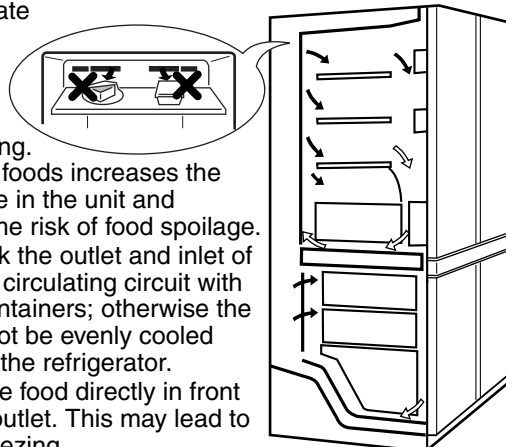

## FOR BEST FREEZING

- Quality of foods should be fresh.
- Freeze small quantities of food at a time to freeze them quickly.
- Food should be properly stored or covered and the air should be removed to seal tightly.
- Evenly place the food in the freezer.
- Label bags or containers to keep an inventory of freezing food.

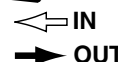

# CARE AND CLEANING

Some household cleaning chemicals may affect the inside surfaces and plastic shelves resulting in splitting or cracks occurring.

When cleaning all plastic parts inside this refrigerator, only use diluted dishwashing liquid (soapy water). Make sure that all plastic parts are thoroughly rinsed with water after cleaning.

The alkaline detergent affects on the aluminum section of the door handle, becomes cause of tarnish.

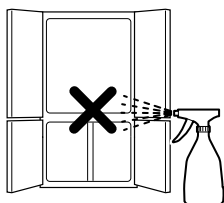

1. Remove the shelves and pockets from the cabinet and door. Wash them in warm soapy dishwashing water; rinse in clean water and dry.
2. Clean the inside with a cloth soaked in warm soapy dishwashing water. Then, use cold water to wipe off soapy water.
3. Wipe the exterior with a soft cloth each time it is soiled.
4. Clean the Magnetic door seal with a toothbrush and warm soapy dishwashing water.
5. Wipe the control panel with the dry cloth.

## NOTE:

- Do not use polishing powder, benzene, hot water etc.
- If undiluted detergent is used or soapy water is not wiped off thoroughly, cracking of plastic parts can result.
- Wipe any food oils adhered to plastic components as they can cause cracking of the plastic surface.
- The glass shelves weigh approximately 3 kg each. Hold firmly when removing from the cabinet or carrying.
- When dropped the juice and the like near the control panel, wipe off directly. It becomes cause of failure of the control panel.

## When the compartment light is blown

Contact the Sharp Service Center to request a replacement compartment bulb. The compartment bulb is not to be removed other than by qualified service personnel.

## Switching off your refrigerator

If you switch your refrigerator off when you are going away for an extended period, remove all food, clean the interior thoroughly. Remove the power cord plug from the power socket and leave all doors open.

# WHAT TO DO BEFORE YOU CALL FOR SERVICE

Before you call for service, check the following points.

**IT IS NORMAL** for the refrigerator to produce the following sounds.

- Loud noise produced by the compressor when operation starts --- Sound becomes quieter after a while.
- Loud noise produced once a day by the compressor --- Operating sound produced immediately after automatic defrost operation.
- Sound of flowing fluid (gurgling sound, fizzing sound) --- Sound of refrigerant flowing in pipes (sound may become louder from time to time).

- Cracking or crunching sound --- Sound produced by expansion and contraction of inner walls and internal parts during cooling.
- Squeaking sound --- Sound produced by expansion and contraction of internal parts.

**IT IS NORMAL** that the outside of a cabinet may be hot when touched. The hot pipe is in the cabinet in order to prevent dew generation.

## IF YOU STILL REQUIRE SERVICE

Refer to your nearest service agent approved by SHARP.

1. 本冰箱為密封式結構。**為防止發生兒童的窒息意外**，請在扔棄冰箱以前，將冰箱門完全拆下。
2. 乙醚、汽油、丙烷氣、粘合劑、純乙醇等高揮發性物質和易燃性物質有爆炸之危險。請勿將這類物質保存在冰箱內。
3. 為防止冰箱的外表受到損害，請勿使噴漆及塗料等接觸冰箱。
4. 擦拭冰箱時，請勿直接將水灑在冰箱的內部和外部。這樣會導致生鏽及絕緣性能下降。
5. 當清潔任何與電氣元件相鄰的區域時，請先拔下冰箱插頭，以防觸電。
6. 不慎將水灑在電路上的部件上時，請先拔掉冰箱的插頭，使該部件乾透，然後就近與 SHARP 認可的售後服務中心聯繫。
7. 在拔掉電源插頭時，不要觸摸插銷。否則將導致觸電。
8. 本冰箱是按照說明書所示的方法使用、為保存家庭的食品而設計的。若將其使用於其他目的上，會對人或財產造成損害。
9. 本冰箱不宜用來貯藏需要準確溫度的物質。這類物質一旦變質，將是很危險的。
10. 電源插頭上積滿灰塵是引起火災的原因。因此，請時常將其擦淨。
11. 請勿改裝冰箱。修理技術人員以外的人員拆卸和修理本機，會導致火災、觸電和受傷。
12. **關於處理廢舊冰箱的注意事項**  
請妥善處理可燃性絕熱發泡氣體。機殼和箱門請運送至可燃性絕熱發泡氣體廢料處理廠。

## 安全注意事項

1. 電源因某些原因中斷時，請等至少 5 分鐘之後再插上電源動作。因為壓縮機所承受的冷媒壓力會使過負荷繼電器跳閘。
2. 不要用濕手去觸摸冷凍室內的食品和金屬製容器。恐會導致手凍傷。
3. 為防止電源鬆脫，請為冰箱的插頭準備一個專用插座。由於電源不穩定會導致保存在冰箱內的食物腐爛變質，所以請勿採用多蕊線配線方式。
4. 因為瓶子凍結後會碎裂，因此，請勿將這類東西放進冷凍室內。
5. 請妥善關好冰箱門。冰箱門即使是稍微開啓，所調節的內部溫度將會升高，因而導致食物的腐爛和電費的增加。
6. 請勿將冰箱設置在濕氣多及濺得到水的地方。這樣會因絕緣失效而導致漏電。而且有時會在冰箱外側結露。
7. 在安裝和搬移冰箱時，請勿挾住或擰彎電源線。由於電源線的損壞有時會導致觸電和火災。
8. 當電源線和電源插頭受到損壞、或是插頭沒有被插緊時，請勿使用冰箱。這樣會導致觸電和著火。
9. 拔出電源插頭時，請不要祇拉住電源線，應該拿住插頭端拔出。拉扯電源線會導致觸電和著火。
10. 為防止壓縮機的過熱和停止運轉，冰箱的周圍要留有足夠的通風空間。請按照安裝程序進行。
11. 冰箱的背面及內部的冷卻系統內裝有冷媒劑。冷卻系統上若有開孔，會給冰箱帶來重大的損害。因此，請勿使尖銳的物體碰觸冷卻系統。
12. 電源線損壞時，請到 SHARP 的售後服務中心更換。因為需要特定的電源線。
13. 萬一發生瓦斯氣漏事故，請勿用手去觸摸冰箱和插頭，要打開窗戶通風。
14. 勿將重物和易碎物品放在冰箱上。這類物品會因開啓冰箱門而掉落下來，從而導致身體受傷。
15. 勿將裝有液體的容器放在冰箱上。液體潑翻時會導致觸電或火災。
16. 在冰箱內請勿使物體掉落，或用物體強烈碰撞內壁。否則可能導致內壁破裂。
17. 小孩或殘障人士使用此冰箱時必須有人監督。尤其注意不要讓小孩玩耍冰箱。

# 安裝

- 為給予冰箱適當的通風環境，建議您在冰箱的左右兩側和背面要預留 6 公分的空隙，上面要預留 9 公分的空隙。若留出的空間不足，則會導致散熱不良，消耗過多的電力。

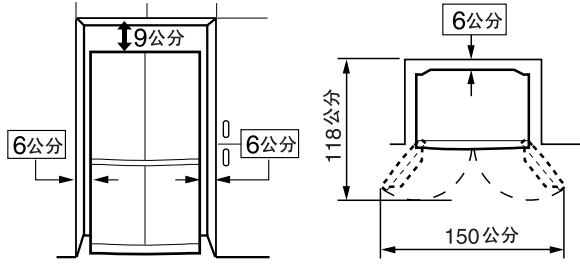

- 請利用前面的兩個調整腳，將冰箱穩妥地安裝在地板的水平位置上。

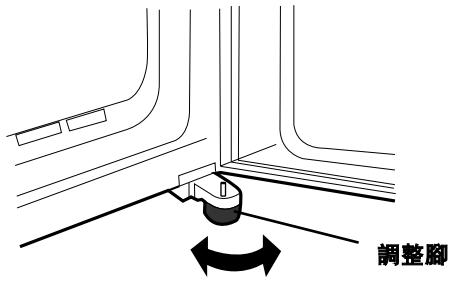

- 當左右門沒有完全對準時通過調整腳來調整。

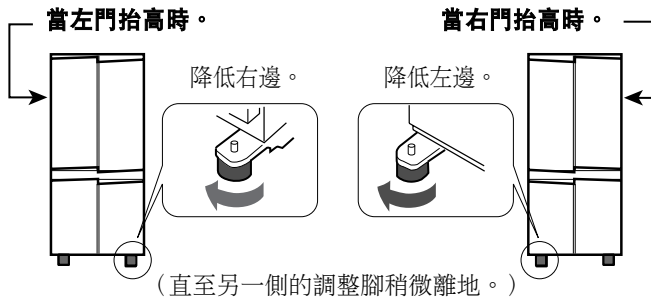

- 卸下冰箱櫃體下部的 4 顆螺絲，然後用卸下的 4 顆螺絲安裝調整腳蓋（在冷藏室內）。

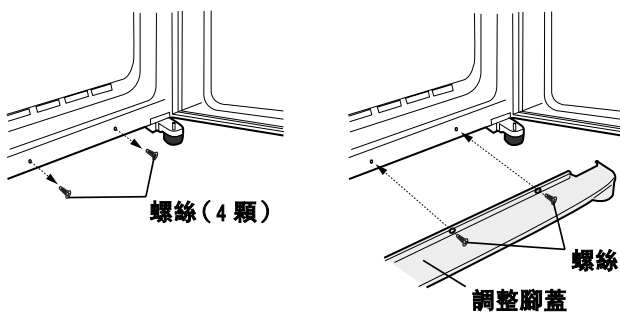

- 為防止觸電，請將地線連接至冰箱背面的地線用螺絲上。（2 腳插頭地區）

## 請注意：

- 設置冰箱時要充分考慮便於插拔插銷。
- 請勿將冰箱放在直接照射到陽光的地方。
- 請勿將冰箱放在發熱機器的旁邊。
- 請勿將冰箱直接放在地面上。請準備適當的台座。
- 在打開冰箱門的狀態下插入電源插銷時，會有冰箱門報警鳴響，但是這不屬於異常。關上冰箱門後報警就會停止。

## 搬運時

- 可以使用移動車輪前後移動。



- 請用冰箱背面和底部的把手進行搬運。

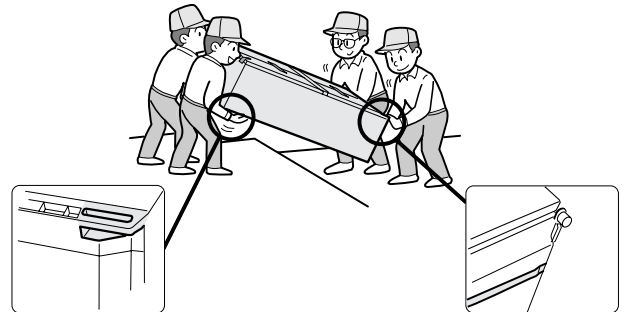

## 在使用冰箱前

用溫水浸泡過的軟布清潔冰箱內部。如果使用肥皂液，請徹底擦掉殘留肥皂液。

# 各部位名稱

SJ-F75PS, SJ-F75PE, SJ-F75PC

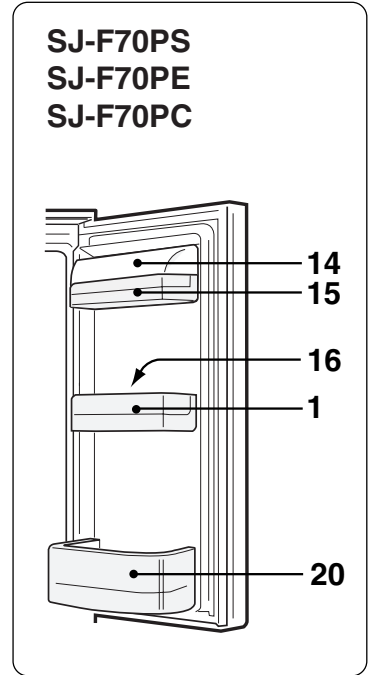
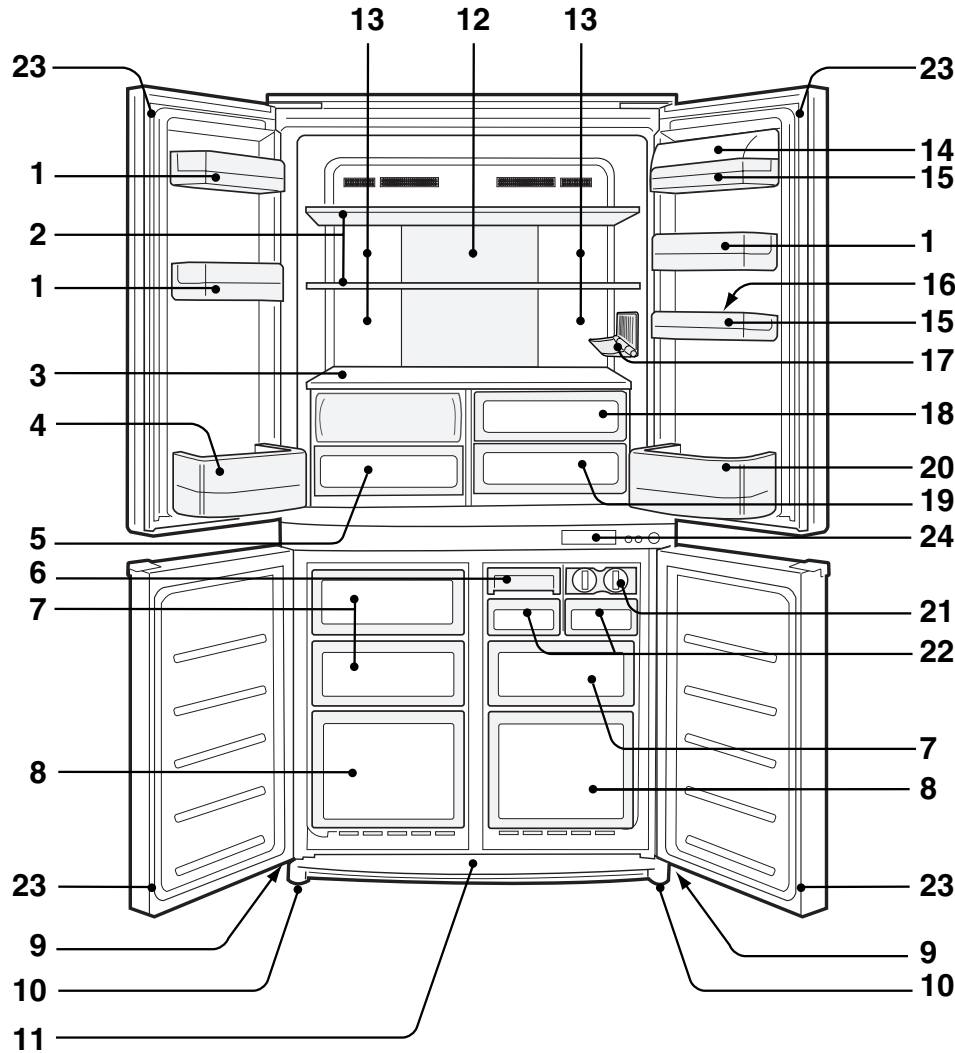

- 1. 門盒
- 2. 冷藏室盤架
- 3. 盤架
- 4. 瓶盒 (左)
- 5. 蔬果保鮮室  
當拉出此盒時，則蔬果保鮮盒蓋打開。
- 6. 快速製冰器 (\*)  
盤底含有用於冰袋的製冷劑，可加快製冰過程。去掉製冰隔離物後，此盤亦可用於冷凍肉類及水果等小件食品。
- 7. 冷凍盒 (小)
- 8. 冷凍盒 (大)
- 9. 移動車輪
- 10. 調整腳
- 11. 調整腳蓋
- 12. 鋁質面板  
本面板從後部受到冷卻，從而間接地使冰箱冷藏室變涼。這是一種冷藏食物的溫和的方法，不會使食物暴露在冷氣流之中。
- 13. 箱內燈
- 14. 小物品架

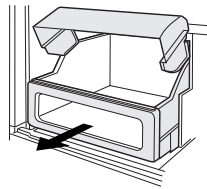

- 15. 小物品架 (\*)
- 16. 蛋架
- 17. 瓶架 (\*)
- 18. 水果盒
- 19. 保鮮盒
- 20. 瓶盒 (右)  
欲存放較大瓶子時，請將隔離物往後移。

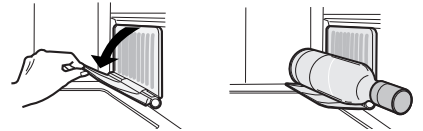

- 21. 旋轉式雙製冰盒 (\*)
  - 請勿將過量的水放入製冰盒內。否則，製成的冰會連結在一起。
  - 冰製成以後，請按順時針方向轉動控制桿，將冰倒進儲冰盒內。
- 22. 儲冰盒  
請勿用儲冰盒製冰或放入油脂類。儲冰盒有時會因之而碎裂。

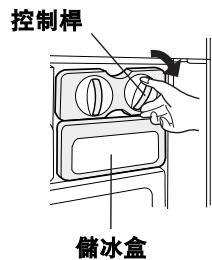
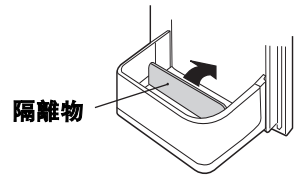

- 23. 門環
- 24. 控制面板

\*

	SJ-F70PS	SJ-F70PE	SJ-F70PC	SJ-F75PS	SJ-F75PE	SJ-F75PC
6. 快速製冰及冷凍盤	1	0	0	1	0	0
15. 小物品架	1	1	1	2	2	2
17. 瓶架	1	1	0	1	1	0
21. 旋轉式雙製冰盒	1	2	2	1	2	2

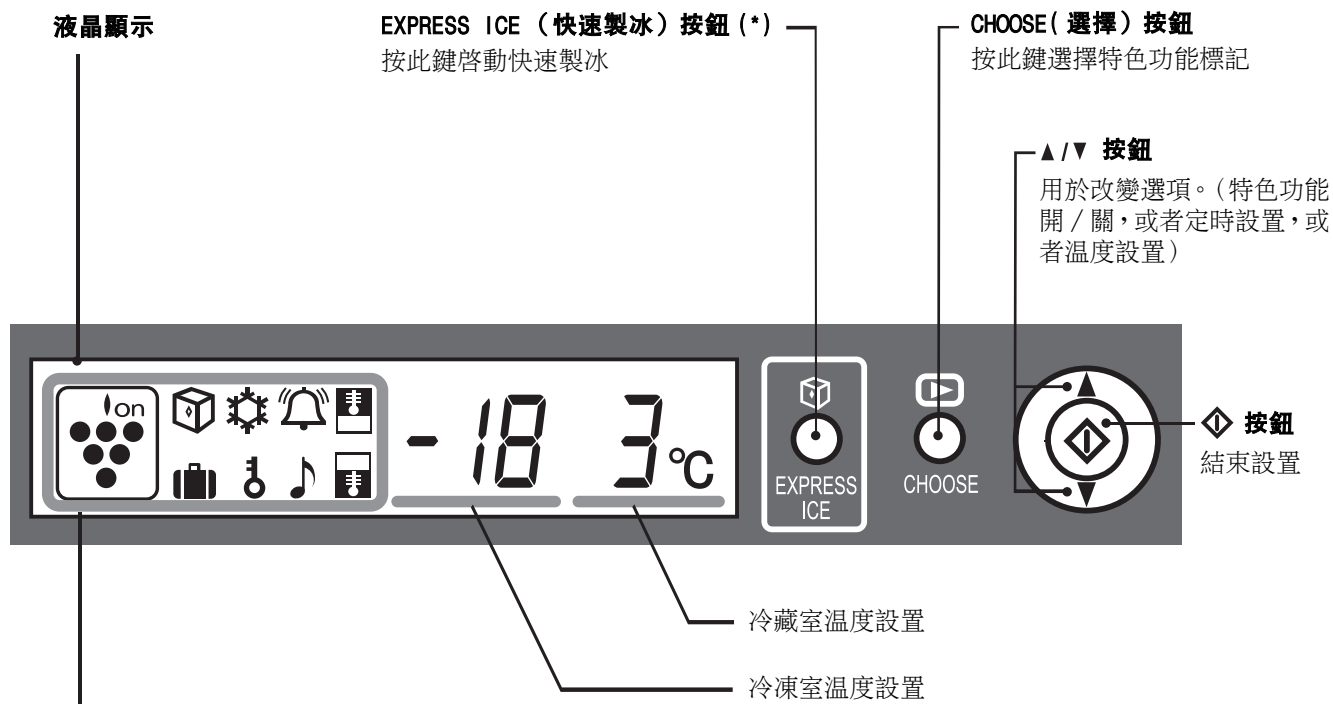

## 每一特色標記

<b>離子簇</b>	<b>冷藏室溫度控制</b>
<b>快速製冰 (*)</b>	<b>冷凍室溫度控制</b>
<b>快速冷凍 (*)</b>	<b>門報警器</b>
<b>定時器</b>	<b>童鎖</b>
	<b>空閑模式 (*)</b>

• 運行中的特色標記將會顯示。

• 插上電源插座後，特色功能將會自動啓動。

• 冰箱因為停電而停止運轉時，再次通電時顯示與停電前相同。但是，在快速製冰、快速冷凍、以及定時器動作中停電時，再次通電時冰箱停止運轉。

\* : 限於 SJ-F70PS、SJ-F70PE、SJ-F75PS、SJ-F75PE

## 請注意：

- 如果連續 30 秒無操作，顯示將會自動回到初始內容。
- 如果連續 3 分鐘無操作，背光將會變暗。
- 如果連續 6 分鐘無操作，背光將會關閉。
- 請勿用鋒利物品擊打或接觸 LCD (液晶顯示) 面板。

## 脫臭裝置

此裝置不需人手操作。祇要插上冰箱的電源，就會自動進入操作狀態。

## 除霜

- 本冰箱透過獨特的節約能源系統，完全實現自動除霜。除霜週期與冰箱的壓縮機運轉時間成反比。也就是說，冰箱的壓縮機運轉時間越短（冬天及因休假而外出時），除霜的周期也就越長。
- 除霜水收集在蒸發盤上，由壓縮器熱量將其蒸發。
- 蒸發盤不需要清潔或維護。

# 使用方法（使用控制面板）



## 溫度調節

本冰箱會自動調節溫度。  
如有需要，請按如下方法調節溫度。

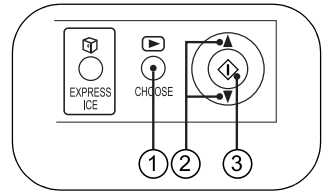

### 冷藏室

- 1 按下“CHOOSE”按鈕並選擇“冷藏室溫度控制”標記。

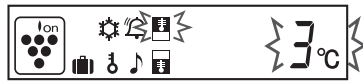

- 2 按下▲/▼按鈕並設定溫度。  
[▲：上升，▼：降低]

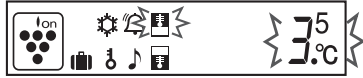

- 3 按下“◊”按鈕。

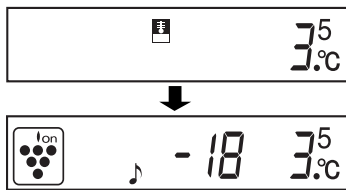

可按 0.5° C 的溫差在 0° C 至 6° C 之間調節。

↑ 6°C	冷藏室過冷時。
3°C	正常情況下的操作。
↓ 0°C	令食物保持新鮮。當冷藏室未能充分冷卻時。

#### 請注意：

- 若長期在溫度為 0° C 下使用冷藏室，冷藏室內的食品有時會被凍結。
- 在周圍溫度較低時，即使將冷藏室的溫度控制調到 6° C，食品有時也會被凍結。



## 快速製冰（限於 SJ-F70PS、SJ-F70PE、SJ-F75PS、SJ-F75PE）

製冰會比平常更快。

- 本功能不能與“快速冷凍”同時使用。

- 1 按“EXPRESS ICE”（快速製冰）按鈕。

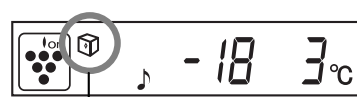

標記出現，運行開始。

- 2 冰塊製成後，移走冰塊。

### 取消運行

再次按“EXPRESS ICE”（快速製冰）按鈕。

#### 請注意：

- 快速製冰將會在約 1 小時後自動結束而製冰狀況無關。（標記將會消失。）
- 當本功能與除霜功能重迭時，快速製冰可能需要 1 小時以上，因為本功能要在除霜之後啟動。
- 當本功能運行之時，盡量避免開門。

### 冷凍室

- 1 按下“CHOOSE”按鈕並選擇“冷凍室溫度控制”標記。

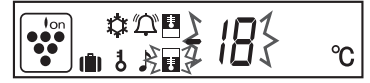

- 2 按下▲/▼按鈕並設定溫度。  
[▲：上升，▼：降低]

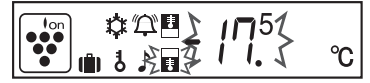

- 3 按下“◊”按鈕。

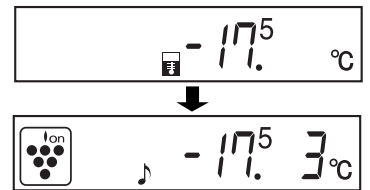

可按 0.5° C 的溫差在 -13° C 至 -21° C 之間調節。

↑ -13°C	不貯藏冷凍食品和冰淇淋時。
-18°C	正常情況下的冷凍。
↓ -21°C	迅速製冰、快速冷凍食品時。

#### 請注意：

- 若長期在溫度為 -21° C 下使用冷凍室，冷藏室內的食品可能會被凍結。

### 如何使用快速製冰器

（限於 SJ-F70PS、SJ-F75PS）

- 提前使冷凍室內的快速製冰器冷卻（至少一天）。
- 在製作完冰塊後，從托盤上拆下隔離物，而後扭轉隔離物的兩端取出冰塊。



#### • 冰塊製成之前的標準時間：大約 20 分鐘

- 在使用冷藏室中保存的水時，室溫為 30° C，將冷藏室溫設為 3° C，冷凍室設為 -18° C。
- 根據室溫、水溫和冰箱門的開合頻度等，製冰時間有時會比上述時間長。
- 注水量超過水位線時，在大約 20 分鐘內不能製冰。而且，冰塊也不易脫落。

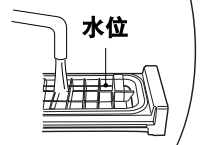

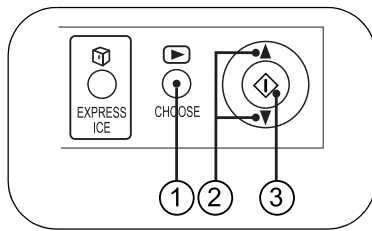

## 離子簇

當冰箱通電時，離子簇將自動進入工作狀態。

### 取消運行

- 1 按下“CHOOSE”按鈕並選擇“離子簇”標記。



- 2 按下▲/▼按鈕並選擇“OFF”（關閉）。



- 3 按下“◊”按鈕。

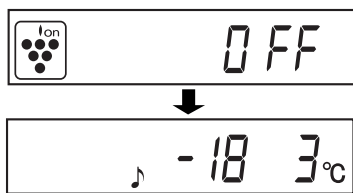

### 開始操作

請以步驟②選擇“ON”（開）。

#### 離子簇操作提示

冰箱內的離子產生器將向冷凍室和冷藏室釋放出離子簇。離子簇是正離子和負離子的集合體。離子簇能有效不活潑空氣中浮遊黴菌。

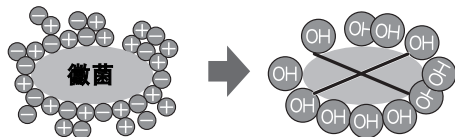

- 冰箱內可能有異味。這是離子發生器產生的臭氧的味道。臭氧密度非常小，釋放到冰箱內的臭氧會迅速分解。



## 快速冷凍（限於 SJ-F70PS、SJ-F70PE、SJ-F75PS、SJ-F75PE）

可以用本功能製作高質量的冷凍食物，對於家庭冷凍十分便利。

- 本功能不可與“快速製冰”功能同時使用。

- 1 按下“CHOOSE”按鈕並選擇“快速冷凍”標記。



- 2 按下▲/▼按鈕並選擇“ON”（開）。

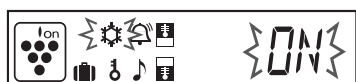

- 3 按下“◊”按鈕。

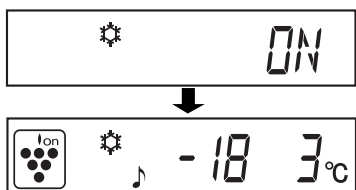

## 定時器

可以按 30 秒的間隔設置，最高可設為 99 分 30 秒。

- 1 按下“CHOOSE”按鈕並選擇“定時器”標記。將顯示上次所設時間。



- 2 按下▲/▼按鈕並設定時間。

[▲：增加，▼：減少]

持續按住按鈕可快速設定。



- 3 按下“◊”按鈕。



定時器啓動。將顯示剩餘時間。



當設定時間到時，將會響起結束音。（約 30 秒）。欲停止結束音，請按“◊”。



### 取消定時器

- 1 按“CHOOSE”（選擇）選擇“定時器”標記。



- 2 按下“◊”按鈕。

### 請注意：

在定時器工作中不能夠再次設定定時器。



快速冷凍將在約兩小時後自動停止。（標記將會消失。）

### 取消運行

請以步驟②選擇“OFF”（關）。

### 請注意：

- 大件食物不能在單次操作中冷凍。
- 當本功能與除霜功能重疊時，快速製冰可能需要兩小時以上，因為本功能要在除霜之後啓動。
- 當本功能運行之時，儘量避免開門。



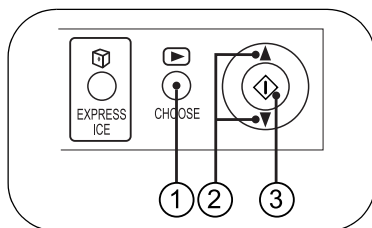

## 門報警器

當冷藏室或者冷凍室沒有關閉時，門報警器會響起。

- 門報警器將會在開門 1 分鐘後響起，並過 1 分鐘後再次響起（每次響一次）
- 如果門保持開啓狀態約 3 分鐘，報警器將會連續響起。

### 取消運行

- ① 按下“CHOOSE”按鈕並選擇“門報警器”標記。



- ② 按下▲/▼按鈕並選擇“OFF”（關閉）。



- ③ 按下“◊”按鈕。

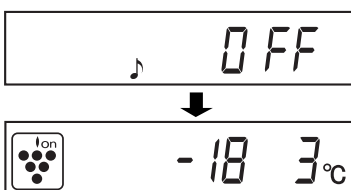

### 開始操作

請以步驟②選擇“ON”（開）。

## 童鎖

控制面板上的一些關鍵操作可以被禁止。此功能可以防止兒童或者他人隨便操作控制面板。

- ① 按下“CHOOSE”按鈕並選擇“童鎖”標記。



- ② 按下▲/▼按鈕並選擇“ON”（開）。



- ③ 按下“◊”按鈕。

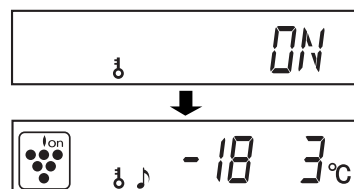

### 取消運行

- ① 連續按住“CHOOSE”（選擇）按鈕 2 秒鐘以上。

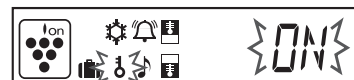

- ② 通過▲/▼按鈕來選擇“OFF”（關）並按下“◊”。

## 空閑模式（限於 SJ-F70PS、SJ-F70PE、SJ-F75PS、SJ-F75PE）

當外出旅行或者長時間離家時使用本功能。

- ① 按下“CHOOSE”按鈕並選擇“空閑模式”標記。



- ② 按下▲/▼按鈕並選擇“ON”（開）。

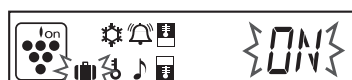

- ③ 按下“◊”按鈕。

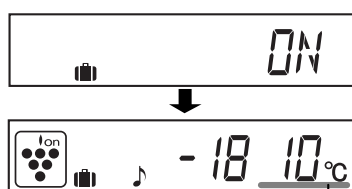

冷藏室內的溫度可調至 10° C。這一溫度不可更改。

### 取消運行

請以步驟②選擇“OFF”（關）。

### 請注意：

由於冷藏室內的溫度成為 10° C，冷藏室中的食品保存期限成為通常運轉情形下的大約 1/2 ~ 1/3。請僅在沒有易腐爛食品的時候使用。

# 食品的儲存

將食品冷藏起來時，食品腐爛的速度就會減緩。要延長易於腐爛食品的保存期限，就應當盡可能選擇較新鮮的食品。下面為延長食品保存期限的簡要介紹，可供您參考。

## 水果／蔬菜

為儘量減少水份的流失，水果和蔬菜要用保鮮膜及袋子（不封口）之類的塑膠袋輕輕包上，並將其放入蔬果保鮮室內或者水果盒內。柳橙等表皮較厚的水果或蔬菜則不用保鮮膜包上即可放入。

## 乳製品和雞蛋

- 幾乎所有乳製品的外包裝上都標有適當的保存溫度和保存期限。
- 請用箱內的蛋架保存雞蛋。

## 肉類／魚／禽肉

- 請將其放在容器上，並包上保鮮膜。
- 若是大塊的肉、魚和禽肉，請將其放在盤架的內側。
- 已經煮熟的食品務須用保鮮膜包好，或將其放在密封容器內。

## 請注意：

- 為使冷氣充分循環，請將食品均勻地放在盤架上。
- 請將較熱的食品涼下來以後，才保存起來。如果將較熱的食品放進冰箱，冰箱內的溫度會升高，這樣往往很容易導致食品腐爛變質。
- 請勿讓食品和容器擋住使冷氣循環的出風口和吸入口。否則，食品就不能均勻地冷卻。
- 請勿直接將食品放在冷氣出風口旁。這樣會引致食品凍結。

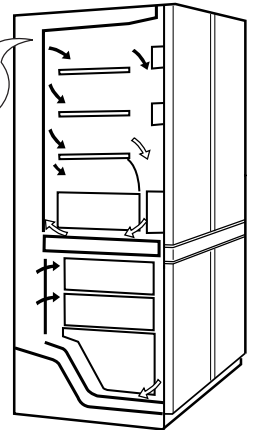
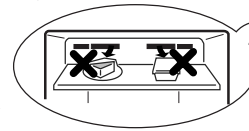

## 為達到最佳冷凍效果

- 食品質量應當新鮮。
- 若要快速冷凍食品，每次都必須少量放入。
- 食品應適當地放入容器或用保鮮膜包好，若要將食品密封起來，最好將空氣抽出。
- 將食品均勻地放入冷凍室。
- 袋子和容器上要標上標示，並寫清楚冷凍食品的內容。

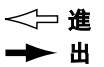

# 保養

某些家用化學洗滌劑可能會腐蝕冰箱內壁和塑料盤架，並導致裂縫的產生。

當清洗冰箱內所有的塑料部件時，祇能使用稀釋過的廚房用洗滌劑（肥皂水）。洗滌完畢後務必用水徹底洗清。

鹼性洗劑會影響冰箱門把手的鋁部分，恐會引起變色。

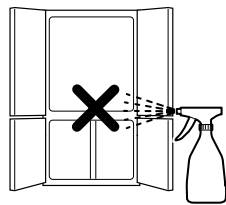

1. 拆下冰箱內的盤架和冰箱的小物品架，瓶架。用溫水和廚房用洗滌劑清洗。用水洗清並使之乾透。
2. 冰箱內部要用浸泡在廚房用洗滌劑的溫水裡的布塊擦洗。然後，用冷水將肥皂水擦乾淨。
3. 冰箱的外殼沾上污漬時，請用柔軟的布塊擦洗。
4. 冰箱門環要用廚房用洗滌劑的溫水和牙刷洗淨。
5. 請用乾布擦拭控制面板。

## 請注意：

- 切勿使用研磨粉，輕質汽油和熱水等。
- 如果使用未稀釋的洗劑或者未徹底擦淨肥皂水，則有可能損壞冰箱的塑料部件。
- 食用油沾上塑料部件時，請將之擦掉。因為這類油會致使塑膠表面產生裂縫。
- 一塊玻璃盤架約重 3kg。從箱內抽出或搬運時請小心托牢。
- 控制面板附近濺到果汁等時，請馬上將其擦掉。否則將導致控制面板的故障。

## 當冷藏室內燈損壞時

請聯繫 SHARP（夏寶）服務中心要求更換冷藏室內燈泡。非專業服務人員不得更換冷藏室燈泡。

## 切斷冰箱的電源時

長期出門的時候，如果要切斷冰箱的電源，請取出冰箱內的全部食品，並將內部徹底擦洗乾淨。請從插座上拔出電源插頭，並打開冰箱門。

# 送修之前的初步檢查

送修之前，請對下列地方進行檢查。

冰箱如發出下述聲音，**這並非異常**。

- 運轉開始時，壓縮機發出較大的噪音——不久聲音會變小。
- 壓縮機每日一次發出較大噪音——緊隨自動除霜操作之後發出的運轉聲。
- 液體流動的聲音（咕嚕聲、嘶嘶聲）——冷媒在管道內流動的聲音（聲音時而會變得較大）。

- 劈啪聲或吱嘎聲——冷卻時內壁和內部零件膨脹和收縮的聲音。
- 吱吱聲——內部零件膨脹和收縮的聲音。

冰箱外箱有時會變熱，**這並非異常**。防止結露的熱導管裝在機身的內部。

## 經檢查後仍需要送修時

請與就近的 SHARP 售後服務中心洽詢。



**SHARP**  
**SHARP CORPORATION**